

**TEKTRONIX®**

*committed to  
technical excellence*

# TEKSCOPE

Volume 6 Number 1

Mar/Apr 1975

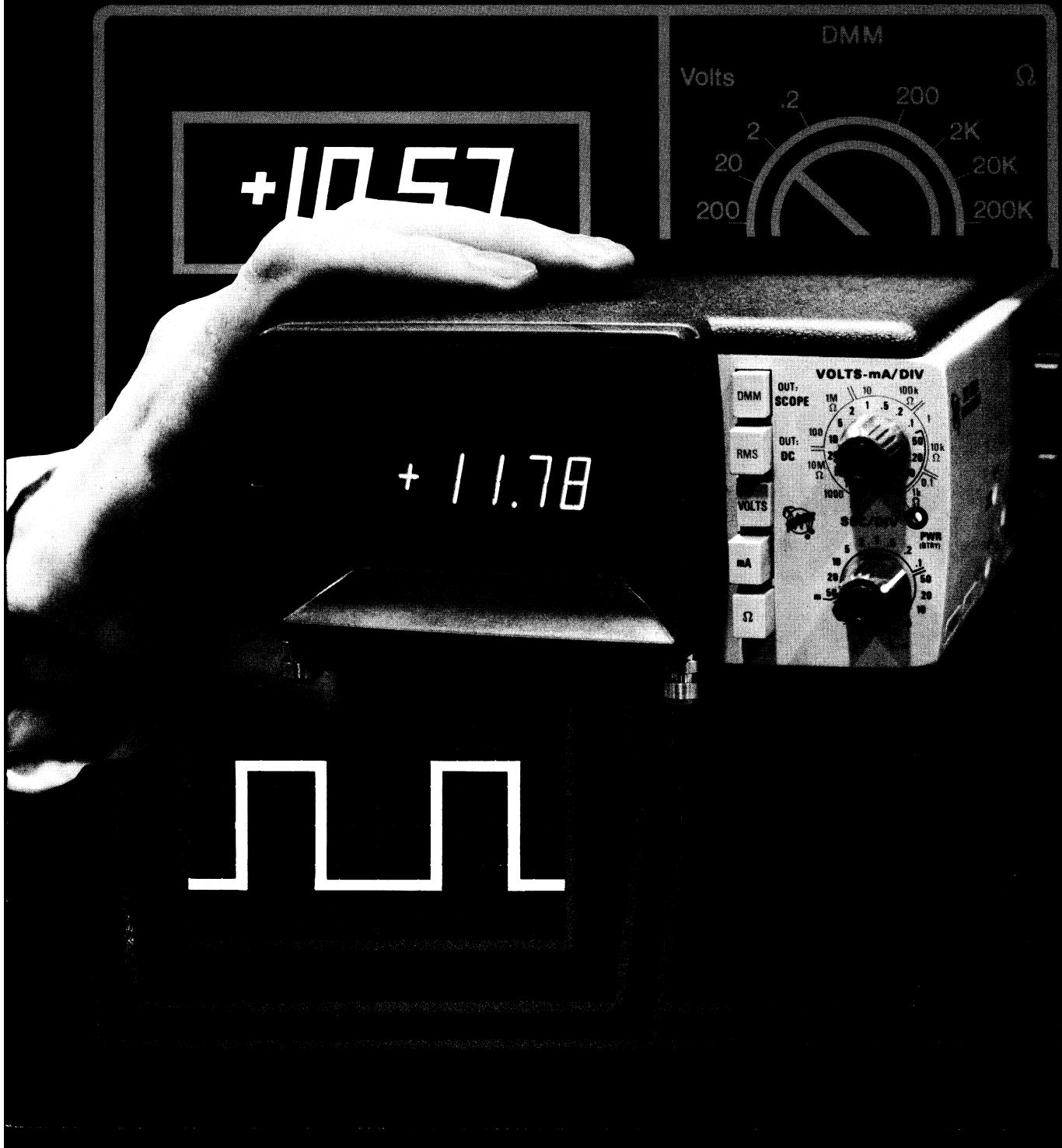



# TEKSCOPE

Customer Information from Tektronix, Inc.,  
Beaverton, Oregon 97077

Editor: Gordon Allison  
Ass't. Editor: John Mulvey

## Contents

### 3 A hand-held DMMiniscop

A full-fledged digital multimeter and oscilloscope are both housed in a single, hand-held, battery powered package designed for maximum portability.

### 7 Sweep delay today

Digital sweep delays offer better accuracy, are easy to use, and have less jitter than analog sweep delays for many applications.

### 12 Digital delay and time base in one plug-in

A single plug-in for 5000-series oscilloscopes contains both digital delay and a time base. A unique circuit yields 10 ns jitter from a 1-MHz clock.

### 15 Troubleshooting digital circuits

Part II gives some practical pointers on isolating problem areas, and some do's and don'ts in logic troubleshooting.

**Cover:** Two of the electronics industry's most widely used instruments are merged into one in the TEKTRONIX 213 DMM Oscilloscope. The instrument weighs less than four pounds, including batteries.

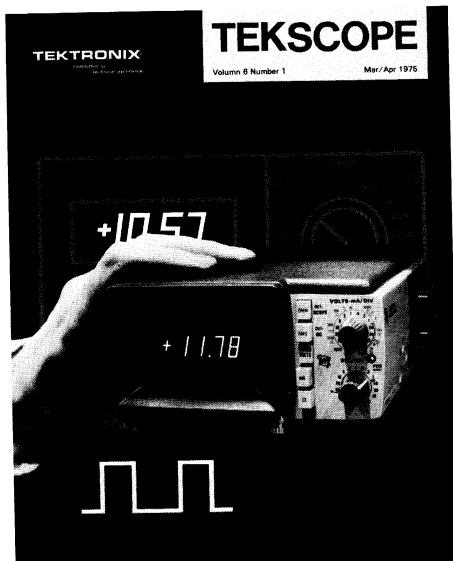

Copyright © 1975, Tektronix, Inc. All rights reserved. U.S.A. and Foreign Products of Tektronix, Inc are covered by U.S.A. and Foreign Patents and/or Patents Pending. TEKTRONIX, SCOPE-MOBILE, TELEQUIPMENT and  are registered trademarks of Tektronix, Inc. Printed in U.S.A.

# A hand-held DMMiniscope



Dave Allen

**H**ow do you pronounce DMMiniscope? Some may say "DMM miniscope," others "DMM in-a-scope." Either way it accurately describes the new TEKTRONIX 213 DMM Oscilloscope which combines a  $3\frac{1}{2}$ -digit digital multimeter and a 1-MHz oscilloscope in one compact instrument weighing only 3.7 pounds and measuring 3.0 x 5.2 x 8.9 inches. You can hold it easily in the palm of your hand or suspend it from a convenient neck strap. It's battery powered and ready to make measurements wherever you take it.

## The DMM

The 213 makes all of the measurements associated with a high performance,  $3\frac{1}{2}$ -digit multimeter and displays the results in large clear numbers on the crt (1 cm x 4 cm for the four digits, plus sign and decimal point). The brightness of readout is set by the side-panel INTENSITY control.

Dc voltage and current are measured on five ranges from 0.1 V full scale to 1000 V full scale, and 0.1 mA to 1000 mA full scale. True rms readings of ac voltage and current are provided over these same ranges for frequencies up to 40 kHz. If dc coupling is used in the rms mode, the readout will show the true rms value of ac plus dc. Since rms and dc voltage measurements are made using the oscilloscope probe, you can view the waveform, or measure the voltage at the same point by simply pressing a front-panel pushbutton. That's all it takes to transform the oscilloscope into a DMM, or vice versa.

In the DMM mode, resistance is measured with an accuracy of 1% or better over five ranges extending from 1 k $\Omega$  full scale to 10 M $\Omega$  full scale.

Excellent overrange capability of 200% full scale is provided for all ranges except the 1000 V, where input is limited to 800 V because of probe and input component considerations.

## The oscilloscope

Although small in size, the 213 offers many of the features of much larger oscilloscopes, and some even the larger scopes don't offer; for example, a built-in capability for viewing current waveforms, with calibrated deflection factors from 5  $\mu$ A/div to 100 mA/div. Current waveforms are viewed using the mA- $\Omega$  input on the instrument side panel. Input shunt resistance ranges from 0.3  $\Omega$  to 1000  $\Omega$  depending on the current range.

## Why combine a DMM and scope?

There are basic similarities between a DMM and an oscilloscope. Both have calibrated sensitivities, or measurement ranges; both require some form of readout, or display; and both are used by those engaged in designing, manufacturing and servicing electronic equipment. These few similarities make it worth considering means to combine the two instruments, especially for those applications demanding portability.

The TEKTRONIX 200-Series Oscilloscope package was selected as ideal from the standpoint of portability. It was small enough to hold in the hand, had a rugged, double-insulated case for elevated voltage measurements, and was battery operated. The crt would make an excellent readout device for digits as well as waveforms. The major problem was space. How do you get the circuitry required for a DMM inside a package already designed for the minimum volume needed to house the oscilloscope circuitry?

A partial answer is to make the circuitry do double duty—serve both func-

tions. While an obvious solution it's not as simple to achieve as it appears. For example, both instruments need an input attenuator but the requirements are quite different. The oscilloscope needs a wide-band, "clean" attenuator; the DMM a higher precision attenuator, 10 megohm input impedance, and not much bandwidth. A self-imposed requirement dictated using the same probe for both oscilloscope and DMM voltage measurements, for operator convenience.

#### Common input circuitry

The 213 uses a straight-through (1X) probe working into a 10-megohm attenuator. A Tektronix-designed cam switch provides five ranges for DMM voltage, current and resistance measurements, and 14 calibrated steps for oscilloscope voltage and current waveforms.

The input amplifier also serves both the DMM and oscilloscope. Discrete component design was selected to obtain sufficient bandwidth for the oscilloscope and achieve the 0.1% gain accuracy required for the DMM. The output of the input amplifier is connected to either the DMM or oscilloscope circuitry by a front-panel switch. The same switch applies operating voltage to only those circuits needed to perform the function.

The DMM circuitry is similar to that used in other TEKTRONIX DMM's, with special attention given to achieving maximum performance within the space and power available. Overrange indication serves as an excellent example of the value engineering found in the 213. There are basically three possible sources of error due to an overrange signal: the Input Amplifier, the A/D Converter, and the RMS Converter when the permissible crest factor is exceeded. Overrange indication is provided in each of these circuits, with overrange indicated on the readout display as scrambled plus and minus character segments, and 8's.

#### The DMM readout

Readout for the DMM is provided by a novel Tektronix-designed character generator IC that produces X, Y and Z signals to drive the crt deflection and blanking system. The X and Y signals always form the seven-segment display character 8. To form the characters 0 through 9, the character generator converts serial BCD data inputs into Z-axis (or blanking) output signals to blank the necessary segments. The BCD data consists of four groups (one group for each character) supplied from a 4-decade counter IC. Also supplied from the counter are four outputs that provide spacing current to the horizontal amplifier to properly position each character displayed. The character generator also produces plus or minus polarity signs and the decimal point. A portion of the Y output signal is fed to the horizontal amplifier, giving the displayed numerals a slight tilt for a more pleasing appearance.

#### The power supply

One of the most challenging design goals of the 213 was to power the instrument from just two nickel-cadmium D cells providing 2.4 volts dc. These two batteries power a high-efficiency supply producing voltages of 0.6 volts ac, and +6.5, -6.5 +15, +75, and -1000 volts dc. Efficiency is about 78%.

The inverter is a switching regulator type in which the amount of energy transferred to the transformer secondary is determined by the on-time of the switching transistor. On-time is controlled by the frequency of an astable multivibrator. As battery voltage decreases, the operating voltages decrease. This results in a change of the astable multivibrator frequency

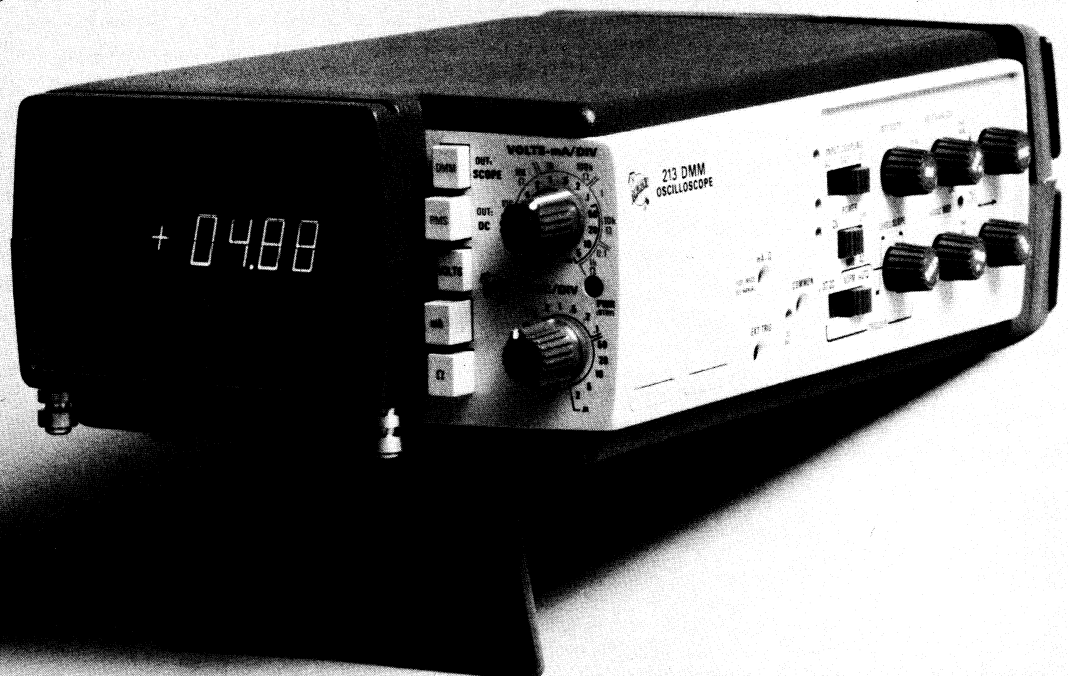

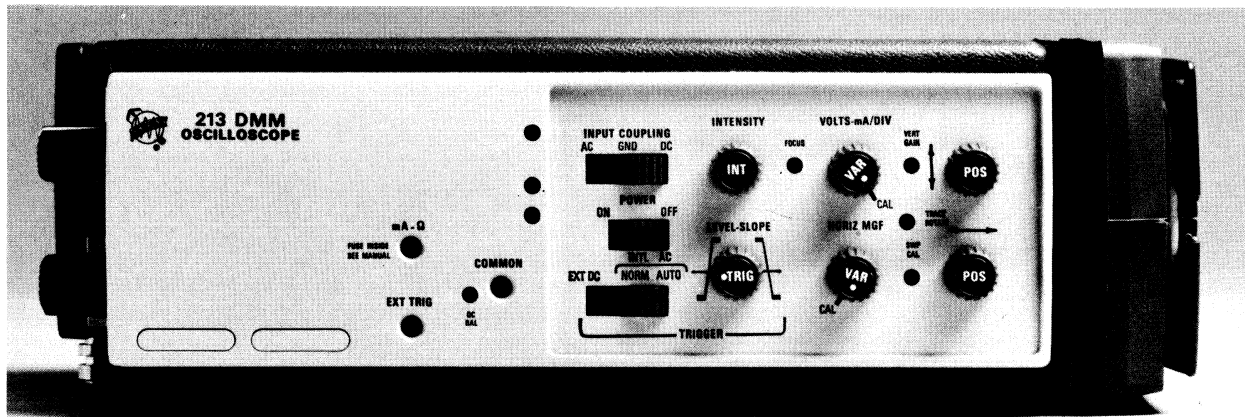

**Fig. 1.** Side view of the 213 showing the current and ohmmeter inputs, and other instrument controls. The oscilloscope probe and power cord are wrapped in place at the rear of the instrument.

which alters the on-time, restoring operating voltages to normal.

#### Low-voltage shutdown

A low-voltage shutdown circuit operates as a battery condition indicator and battery deep-discharge protector. When battery voltage drops to +2.12 volts, the power indicator LED extinguishes. Operation will continue until battery voltage reaches about +2.02 volts. At this point an SCR conducts, effectively shutting down the astable multivibrator and, thus, the supply.

#### Low voltage supplies

The low-voltage rectifier-filter circuitry uses Schottky-barrier diodes which provide low power dissipation because of reduced junction voltage. The Schottky-barrier diodes also provide fast recovery needed at the high multivibrator frequency ( $\approx 60$  kHz), resulting in an increase in power supply efficiency.

#### High voltage supply

High voltage is generated by an 8-stage multiplier that takes about 190 volts peak-to-peak from the inverter and produces about 1300 to 1400 volts across the multiplier. The crt accelerating voltage is obtained after the seventh stage of multiplication and is set to  $-1000$  volts and regulated to within 1%.

#### The battery charger

The 213 contains a battery charger converter that enables the batteries to be charged when connected to the power line. Charging occurs with the instrument turned on or off. The converter is frequency controlled, with the battery charge current regulated by a saturable reactor. As current flow changes in the saturable reactor, its inductance changes causing a shift in the operating frequency of the converter. As the converter frequency shifts away from resonance, the output voltage decreases, regulating the charge rate.

#### Mechanical considerations

One of the outstanding achievements in the 213 design is the packaging. Nearly every cubic inch inside the package is occupied. There is no main chassis in the unit. Five printed circuit boards surrounding the crt are interconnected by square pins mounted on one printed circuit board, inserted into jacks on the adjoining board. Only a few interconnecting cables are needed. The two-piece insulated cabinet fits snugly around the assembly, maintaining the boards securely in place and providing operator protection for elevated voltage measurements.

#### Servicing the 213

Troubleshooting the 213 is simplified by using extender cards for the A/D Converter Board and Power Supply Board. Extending these two boards opens up the 213 for easy access to circuitry while the instrument is operating. The extender boards are available from Tektronix.

#### Acknowledgements

A project such as the 213 requires the closest of cooperation between the mechanical and electrical designers. The result describes better than words, the dedication each brought to the task.

As Project Engineer my special thanks go to Ilmars Smiltins for mechanical design; John Pace, who did the input attenuators, input amplifier, Gm Converter, Ohms Converter, and scope preamplifier; Jim Knowlton for design of the high-efficiency power supply; Wayne Thomas, who did the horizontal and vertical amplifier; and Wendell Damm for the character generator, RMS converter, and A/D converter design. John Eskeldson was the Electrical Evaluation Engineer and George Kolibaba, Manufacturing Coordinator. My thanks also to the many others who contributed to the success of the 213 program. 

# Specifications on the 213

## DMM

True rms readings of voltage and current are provided for all waveforms with a crest factor of 5 or less.

### Dc and Ac Voltage

**Range**—0.1 V to 1000 V full scale in 5 ranges.

**Overrange Capability**—At least 200% of full scale. Except for 1000 V range.

**Resolution**—100  $\mu$ V at 0.1 full scale.

**Dc Voltage Accuracy\***—For 25°C  $\pm$ 5°C. Beyond these limits add temperature coefficient.

0.100 V Range	Within 0.1% of reading $\pm$ 3 counts. Temp Coef is (within 0.015% of reading $\pm$ 0.04% of full scale) per °C.
1.000 V Range	Within 0.1% of reading $\pm$ 1 count. Temp Coef is (within 0.01% of reading $\pm$ 0.01% of full scale) per °C.
10.00 V and 100.0 V Ranges	Within 0.15% of reading $\pm$ 1 count. Temp Coef is (within 0.015% of reading $\pm$ 0.01% of full scale) per °C.
1000 V Range	Within 0.2% of reading $\pm$ 1 count. Temp Coef is (within 0.02% of reading $\pm$ 0.01% of full scale) per °C.

\*Accuracy for battery operation. For ac line operation add 10°C before computing DMM accuracy temperature coefficient.

**RMS Voltage Accuracy\***—For 25°C  $\pm$ 5°C. Beyond these limits add temperature coefficient. Temp Coef is (within 0.05% of reading  $\pm$  0.1% of full scale) per °C.

	Within % of reading shown $\pm$ 5 counts at frequency shown.		
	Dc	40 Hz to 4 kHz	4 kHz to 40 kHz
0.100 V Range	2.5%	1.5%	3.5%
1.000 V Range	2%	1%	1%
10.00 V Range	2%	1%	1%
100.0 V Range	2%	1%	1%
1000 V Range	2%	1%	2%

\*Accuracy for battery operation. For ac line operation add 10°C before computing DMM accuracy temperature coefficient. Accuracy limit increases linearly for crest factor greater than 2. Up to twice indicated limit for crest factor of 5.

**Input Resistance**—10 M $\Omega$ .

**Input Capacitance**—Approx. 150 pF on 0.1 V to 10 V ranges, 100 pF on 100 V and 1,000 V ranges.

**Settling Time**—1.5 seconds within 0.1% of reading in dc mode, 2 seconds within 1% of reading in rms mode.

**Maximum Input Voltage**—

500 V (dc + peak ac) for 0.1 V to 10 ranges dc coupled, 800 V (dc + peak ac) for 0.1 V to 10 V ranges ac coupled, 800 V (dc + peak ac) for 100 V and 1000 V ranges.

### Dc and Ac Current

**Range**—0.1 mA to 1000 mA full scale in 5 ranges.

**Overrange Capability**—At least 200% of full scale.

**Resolution**—100 nA at 0.1 mA full scale.

**Input Shunt Resistance (Approximate)**

Scale	Resistance
0.100 mA	1000 $\Omega$
1.000 mA	100 $\Omega$
10.00 mA	10.2 $\Omega$
100.0 mA	1.2 $\Omega$
1000 mA	0.3 $\Omega$

**Dc Current Accuracy\***—25°C  $\pm$ 5°C. Beyond these limits add temperature coefficient. Temp Coef is (within 0.02% of reading  $\pm$  0.04% of full scale) per °C.

0.100 mA Range	Within 0.5% of reading $\pm$ 3 counts
1.000 to 1000 mA Range	Within 0.25% of reading $\pm$ 3 counts

\*Accuracy for battery operation. For ac line operation add 10°C before computing DMM accuracy temperature coefficient.

**RMS Current Accuracy\***—For 25°C  $\pm$ 5°C. Beyond these limits add temperature coefficient. Temp. Coef is (within 0.05% of reading  $\pm$  0.1% of full scale) per °C.

	Within % of reading shown $\pm$ 5 counts at frequency shown.		
	Dc	40 Hz to 4 kHz	4 kHz to 40 kHz
0.100 mA Range	2.5%	1.5%	4.5%
1.000 to 1000 mA Ranges	2.5%	1.5%	3.5%

\*Accuracy for battery operation. For ac line operation add 10°C before computing DMM accuracy temperature coefficient. Accuracy limit increases linearly for crest factor greater than 2. Up to twice indicated limit for crest factor of 5.

**Settling Time**—1.5 seconds within 0.1% of reading in dc mode, 2 seconds within 1% of reading in rms mode.

**Maximum Input Current**—2 A rms or 3 A peak on any scale.

## Resistance

**Ranges**—1 k $\Omega$  to 10 M $\Omega$  full scale in 5 ranges.

**Resolution**—1  $\Omega$  on 1 k $\Omega$  scale.

**Accuracy\***—For 25°C  $\pm$ 5°C.

1 k $\Omega$	Within 0.5% of reading $\pm$ 3 counts. Temp Coef is (within 0.03% of reading $\pm$ 0.04% of full scale) per °C.
10 k $\Omega$ to 1 M $\Omega$	Within 0.5% of reading $\pm$ 1 count. Temp Coef is (within 0.02% of reading $\pm$ 0.02% of full scale) per °C.
10 M $\Omega$	Within 1% of reading $\pm$ 1 count. Temp Coef is (within 0.05% of reading $\pm$ 0.02% of full scale) per °C.

\*Accuracy for battery operation. For ac line operation add 10°C before computing DMM accuracy temperature coefficient.

**Settling Time**—2 seconds within 2 counts.

## Readout

**Number of Digits**—3½ digits plus decimal point and sign.

**Display Size**—1 cm high by 4 cm wide (5 characters).

**Overrange Indication**—Readout displays scrambled characters.

## OSCILLOSCOPE

### Vertical Deflection (Voltage)

**Deflection Factor**—5 mV/div to 100 V/div in 14 calibrated steps (1-2-5 sequence). Accurate within  $\pm$  3%. Uncalibrated, continuously variable between steps and to at least 250 V/div.

**Bandwidth**—Dc to 1 MHz ( $-3$  dB point) for 20 mV/div to 100 V/div deflection factors. Dc to 400 kHz ( $-3$  dB point) for 5 mV/div and 10 mV/div. Lower bandwidth limit ( $-3$  dB point) for ac coupling is 1 Hz or less.

**Input R and C**—10 M $\Omega$  paralleled by approx. 150 pF for 5 mV/div through 1 V/div and 100 pF for 2 V/div through 100 V/div.

**Maximum Input Voltage**—

Input Condition	Maximum Input Voltage
Dc coupled, 5 mV/div to 1 V/div	500 V (dc + peak ac) at 1 MHz or less
Ac coupled, 5 mV/div to 1 V/div	800 V (dc + peak ac) 500 V peak ac component
2 V/div to 100 V/div	800 V (dc + peak ac) at 1 MHz or less

### Vertical Deflection (Current)

**Deflection Factor**—5  $\mu$ A/div to 100 mA/div in 14 calibrated steps (1-2-5 sequence). Accurate within  $\pm$  3%. Uncalibrated, continuously variable between steps and to at least 250 mA/div.

**Bandwidth**—Dc to at least 400 kHz ( $-3$  dB point) for 20  $\mu$ A/div through 100 mA/div deflection factors. Dc to at least 200 kHz ( $-3$  dB point) for 5  $\mu$ A/div and 10  $\mu$ A/div.

**Maximum Input Current**—2 A rms or 3 A peak for any range.

### Horizontal Deflection

**Sweep Rate**—2  $\mu$ s/div to 500 ms/div in 17 calibrated steps (1-2-5 sequence). Accurate within  $\pm$  5%.

**Horizontal Magnifier**—Provides continuously variable sweep rate settings between calibrated settings. Extends fastest sweep rate to at least 0.4  $\mu$ s/div.

### Trigger

**Internal Ac Coupled (Auto)**—Triggers on deflection of 0.5 div or more from 7 Hz to 1 MHz. Sweep free-runs in absence of trigger signal or for frequencies below 7 Hz.

**Internal Ac Coupled (Normal)**—Triggers on deflection of 0.5 div or more from 7 Hz to 1 MHz.

**External Dc Coupled**—Triggers on signals of 1.0 V or more from dc to 1 MHz.

### Crt

6 X 10 div display area, each div is approx. 0.2 in. Internal black line, non-illuminated graticule. P43 phosphor is standard.

## OTHER CHARACTERISTICS

**Power Sources**—Internal Ni Cd batteries provide a typical operating period of 3.5 hours at maximum trace intensity for a charging and operating temperature between 20°C and 30°C. Internal charger provides for charging batteries any time the instrument is connected to an ac line even if the instrument is turned off. Dc operation is automatically interrupted when battery voltage drops below 2 V to protect batteries against deep discharge. Full recharge requires approximately 16 hours. External operation from 90 to 136 V ac (48 to 62 Hz). Option 1 allows operation from an external 180 to 250 V ac (48 to 62 Hz) or dc supply. Power consumption, 8 watts or less.

**Insulation Voltage**—500 V rms or 700 V (dc + peak ac) when operated from internal batteries, with line cord and plug stored. When operated from ac, line voltage plus floating voltage not to exceed 250 V rms; or 1.4 X line + dc + peak ac not to exceed 350 V.

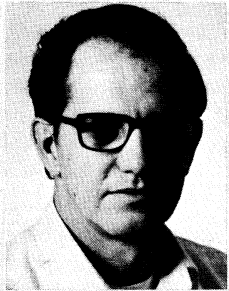

Dave Dunlap

## Sweep delay today

Oscilloscopes with calibrated sweep delay have been around a long time. And most users are probably quite familiar with conventional sweep delay. There are, however, some important new ways to delay sweeps. Have you used digital delay? Do you know when to use digital delay instead of analog delay? Do you know what kinds of digital delay units are available? What are the different ways to minimize display jitter on your crt screen? How much does sweep delay improve time measurement accuracy?

Scope users and buyers should understand this subject to make intelligent selections of the instruments they will need, and to make good use of the instruments they have. We hope to help you understand the subject more clearly.

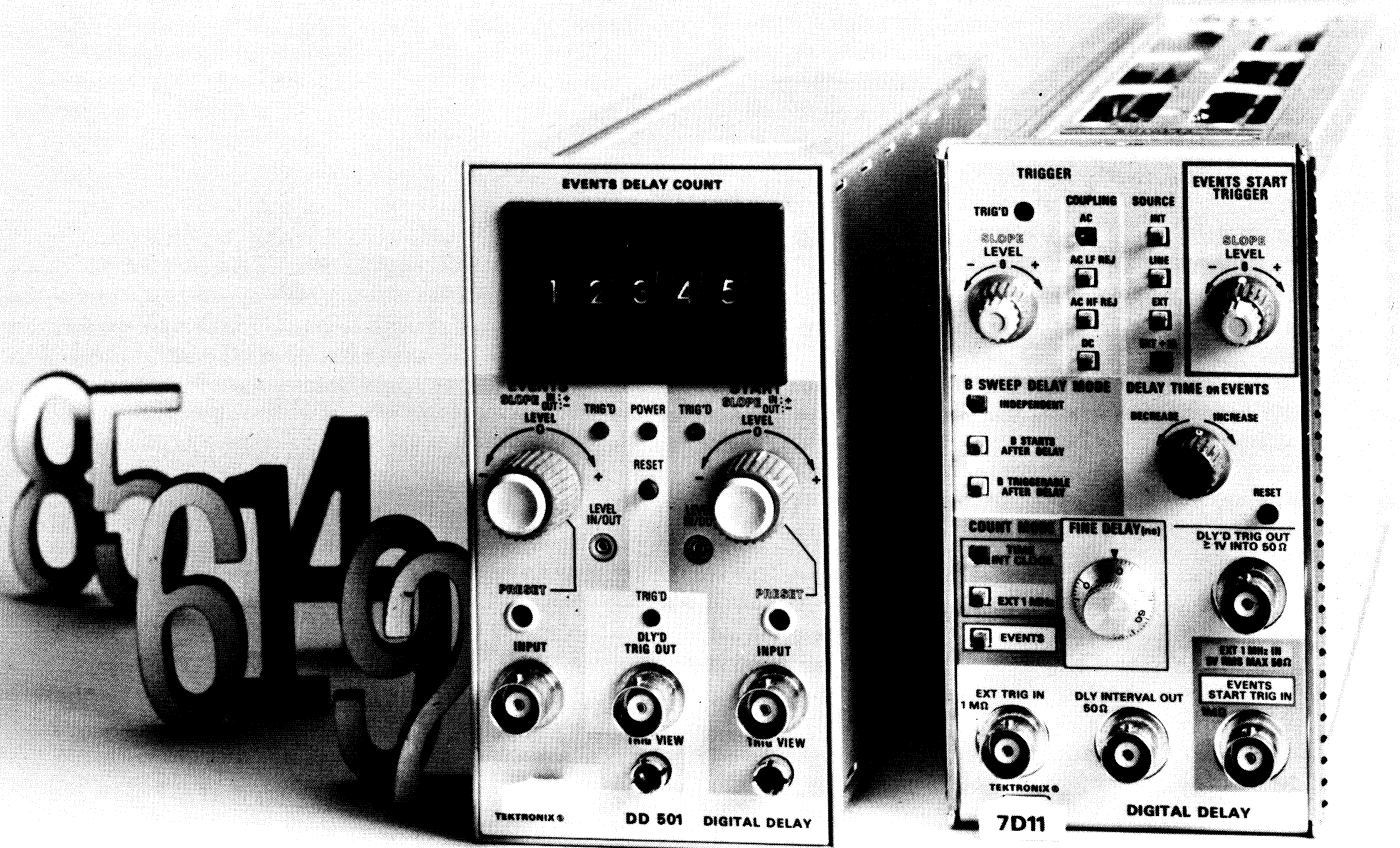



**Fig. 1.** The TEKTRONIX 475 provides analog sweep delay using a calibrated ten-turn potentiometer. On some scopes this control is called the DELAY TIME MULTIPLIER. The number of dial divisions between the start and the end of delay is multiplied by the TIME/DIV setting, to compute delay.

### Conventional calibrated sweep delay

Conventional sweep delay is most often used for the same reason you sometimes use a sweep magnifier . . . to get a better look at something not near the beginning of the sweep. When you magnify a sweep most of the former display goes off screen. To see any of those regions again you merely adjust the horizontal position control. To accomplish the same thing using conventional sweep delay you switch to delayed-sweep operation and rotate the delay control to see what you want. In effect, the amount of magnification is equal to the ratio of the delay range to the duration of the sweep being delayed and is frequently greater than 1000 to 1. Without either sweep delay or sweep magnification, the only time you can see what you want, at the sweep speed you want, is when that event immediately follows the instant of trigger recognition. To see events that happen considerably later requires considerable delay.

The conventional way to delay a sweep is to (1) initiate a ramp signal that (2) generates a secondary trigger signal when it crosses a selectable voltage level, and (3) let that trigger initiate the sweep you need to display the later events. The delay you need is selectable with two controls: one sets the slope of the ramp and the other sets the voltage level the ramp must cross. By generating linear ramps, and by using a linear multi-turn potentiometer for the delay control, delay can be accurately calibrated.

Now when you are looking for a particular freightcar in the middle of a wave train you will not always know how to recognize what you are looking for. Bright zones on the trace, indicating the point of delay, often help, but sometimes don't when you are unable to distinguish



**Fig. 2.** The TEKTRONIX 475 with DM40 or DM43 provides analog sweep delay with LED readout. The readout is set to zero at start of the delay and the readout shows the delay time when the DELAY TIME POSITION control is set to the end of delay. No calculations are necessary.

by waveshape or appearance what part of a wave train to look for. You will, however, sometimes know how much delay time is needed to display what you want. Then having *calibrated* sweep delay is important; you just crank in the numbers you need, to see what you want.

That is fine when you know the speed of the train and the length of the cars. But what if you don't know all that and only know that the 138th car is the one you want to put in the scope window? Then you can count them as you parade them past the crt window if need be. When that is so, you probably don't want to personally parade 138 pulses past your crt window counting them as they go, with the possibility of being interrupted somewhere in the middle of the count. And what if the count is 13801?

### Digital Delay

Fortunately, there is a better way. Digital delay-by-count plug-ins are available that will count the pulses for you more quickly, more reliably, and with far less frustration. The 5B31 is one such plug-in. It is used with 5400 Series Oscilloscopes. The 7D11 and DD 501 are two others.<sup>1</sup> The 7D11 is used in 7000 Series scopes; the DD 501 is for use with any scope.

Delay-by-count is digital delay. When you count cycles of a timing waveform before you trigger a sweep, you have digital time delay the same as counting seconds before blast-off. Digital delay makes particularly good sense when working with digital circuits. One waveform often looks so much like another that other means of identification are called for. The count, the number, is sometimes the only identification.

### Display Jitter Eliminated

Delay by count does other things for you. For one



thing it follows time jitter. It follows jitter so well, in fact, that it can make you believe your jittery signal has no jitter. With conventional sweep delay using the Triggerable After Delay mode, you can also sometimes stop display jitter. What's the difference? Mainly that the Triggerable After Delay mode doesn't work where the amount of jitter is greater than the time between adjacent pulses in the region you want to investigate. In such a case if you were trying to trigger the delayed sweeps on the 138th pulse you would find that some were triggered on the 137th or 139th pulse, producing a confused display. The likelihood increases for relatively long delay periods, for example when trying to look at pulse number 13801.

Even when your signal is not jittery, conventional sweep delay can contribute enough of its own jitter to be a problem at times. With analog delay, delay-generated jitter is proportional to the delay range used, not the delay used, and is usually spec'd at either 1/20,000 of the range or 1/50,000 of the range. A delay range of 20 ms (2 ms/div x 10) might contribute as much as 1  $\mu$ s of jitter and still meet a 20,000:1 specification. An effective magnification of 2000 is all it takes to produce one division of jitter with a 20,000:1 spec. If the displayed pulses were less than 1 division apart in such a case and you used the Triggerable After Delay mode to stop jitter, about half of the sweep would be triggered on one pulse and the other half on an adjacent pulse. If all the displayed pulses were identical in shape and spacing you could not tell the difference; but if the pulse shape or spacing was different the display would be confusing. What is worse, the display may even be a little deceptive. For example, you may see a narrow pulse among others but fail to notice that some sweeps run through its baseline, indicating the pulse is only there part of the time.

Delay by count works like Triggerable After Delay to ignore jitter, except that time variations between counts are *completely* ignored. Pulses produced by rotating devices, such as a magnetic disc, usually have widely-varying time intervals from one cycle to the next. Furthermore, the cycles occur at a relatively low rep rate. Jitter is one thing and low rep rate jitter is another. And to make matters worse, alternate sweep operation cuts any basic rep rate in half. Few conditions are worse for a scope operator than to attempt to interpret jittery dual-trace displays using fast sweeps that are blinking at you. Storage is a big help when there is no jitter. And delay by count will stop the jitter.

You don't have to know the right count to delay by count if you can recognize what you are looking for. You can range from one event to the next and parade your wave train past your crt window the same as with conventional sweep delay.

### Time Measurement Accuracy

Digital delay by count provides very accurate time delay intervals whenever it counts very accurate timing signals. Whereas most analog delay systems have a specified accuracy between about  $\pm 3\%$  and  $\pm 0.5\%$  of the reading, digital time delay accuracy depends largely on the accuracy of the timing signal. The TEKTRONIX 7D11 has a built-in 500 MHz timing signal phase-locked to a 5 MHz crystal oscillator that is accurate within  $\pm 1$  part in 2 million. It will count up to 10 million internally generated 100 ns pulses to provide up to 1 second of delay. You can add from 0 to 100 ns of analog delay to the selected number of 100-ns increments, with an accuracy of  $\pm 2$  ns. Two nanoseconds amounts to  $\pm 2\%$  when the delay is close to one 100 ns increment, but is only  $\pm 0.2\%$  or less when the delay is 1  $\mu$ s or more.

Usually more important than accuracy of delay, however, is accuracy of delay *difference*. For all time interval measurements except those less than about 50 ns, sweep delay can be used to reduce time measurement errors. As most scope users know, to make such a measurement with conventional sweep delay, the difference between two delay dial readings is multiplied by 1, 2, or 5 . . . usually in your head. We call such measurements differential time measurements.

The first dial reading is made after the delay control has been used to position the waveform so the beginning point in the waveform for the time measurement coincides with some vertical graticule line. The second reading is taken after the delay control has been rotated to position the ending point in the waveform to the same graticule line. You must always be able to identify the beginning and ending points of a time interval measurement regardless of how the measurement is made. Although this technique is a little more time consuming than making the measurement directly from the crt scale, it is independent of crt non-linearities and possible gain errors of the horizontal amplifier. The technique typically improves accuracy to about  $\pm 0.5\%$  to  $\pm 1.0\%$  of the reading.

Accuracy invariably falls off for measurements of very short time intervals, and precisely where it starts to fall off depends on the particular oscilloscope. It falls off for the same reason that time measurements scaled directly off a crt suffer in accuracy as the distance scaled gets smaller and smaller. The difference is that smaller sections of a potentiometer have to be used instead of smaller sections of the crt scale.

There is no point whatever in trying to use calibrated sweep delay to improve measurement accuracy beyond the crossover where reading directly from the crt (scaling) yields better accuracy. Even with the speed and convenience of a method of making differential time interval measurements, described in the next para-

graph, accuracy improvements for short time intervals are marginal when compared to directly scaling the crt. The crossover depends on what kind of error you are apt to make when scaling the crt directly, compared to matching points in the waveform with a graticule reference line. Few people would consider the difference to be greater than 1/10 major division. That error would be an additional 1% for a 10-division crt measurement, or an additional 2% for a 5-division measurement, etc. See the discussion on time measurement accuracies on page 11.

#### Digital readout of time delay

TEKTRONIX 464, 465, 466 and 475 Oscilloscopes are available with digital multimeters DM40 or DM43 integrally attached<sup>2</sup>, and one thing these multimeters do is provide  $3\frac{1}{2}$ -digit LED readout of differential (delay) time measurements. No dial numbers need to be read, logged, subtracted or multiplied. By merely pressing a ZERO button when the first point in the measurement is positioned on a reference graticule line, the time difference may be read out directly from the four LED's as soon as the second point is positioned to that reference line. Although the technique provides only marginal improvements in accuracy over the conventional method, human errors in mental arithmetic and reading the dial are minimized, and measurement time is reduced dramatically. The reduction in measurement time practically eliminates errors due to delay drift. Delay drift can easily be observed, when it is significant, because it requires continued readjustment of delay to keep the measurement beginning or ending point in the waveform, on the reference graticule line. Delay drift can sometimes appear to be significant when it is not, because the delayed sweep speed is faster than it needs to be.

For time interval measurements more accurate than about  $\pm 0.5\%$ , digital delay plug-ins may be used. The 7D11 can be used to measure  $1\ \mu\text{s}$  intervals with an accuracy of  $\pm 0.2\%$ ,  $10\ \mu\text{s}$  intervals with an accuracy of  $\pm 0.02\%$ , etc. Only digital counters have comparable accuracy and, unlike most counters, the measurements can be made between two points on a waveform that may differ in voltage.

Not all digital delay generators have built-in timing signals like the 7D11. In those cases, to delay by counting cycles of a timing signal instead of by counting cycles of a signal from the equipment under test requires an external time mark generator or similar instrument. If you are looking at digital equipment that has its own clock signal, that signal is usually the best delay reference you could get. Be sure the clock frequency is not higher than the delay generator can count or that the maximum count required does not

exceed the count or readout capabilities of the delay generator. The TEKTRONIX 7D11 will count up to 10,000,000 cycles of a signal having a frequency up to 50 MHz; the DD 501 will count up to 100,000 cycles of a signal having a frequency up to 80 MHz; and the 5B31 will count up to 100,000 cycles of signals up to 35 MHz. The signal cycles you count may be part of the signal you later display, so the scope bandwidth can limit the maximum frequency your delay generator gets to see.

#### Word Recognizers<sup>3</sup>

No discussion of sweep delay should ignore the subject of Word Recognizers. The two basic reasons to delay a sweep are to make time measurements more accurately, or to get a clear, magnified look at something happening later than your available triggers. In many digital circuits the proper moments to trigger to get a clear magnified display cannot be predicted. For example, you may want to display only what happens immediately after the last of all inputs to a logic gate go true, and can't tell which input that will be. The simple solution is to simultaneously probe several points in the circuit under test, with an equal number of probes that go to a device that will recognize the moments when the unique combination of logic states occur. If you can recognize those moments, you can generate the special sweep triggers needed. How many points you have to probe to recognize specific digital words depends on the equipment you are probing. Most digital words are expressed in multiples of four bits (4, 8, 12, 16, etc.) and the TEKTRONIX 821 Word Recognizer is designed with that in mind.

Usually the trigger generated by a Word Recognizer is used to initiate a sweep, but it is also useful to initiate a period of delay before the sweep is initiated. That delay can be digital or analog, depending on your needs. The output from a Word Recognizer is usually applied directly to the external trigger input of a scope or sweep plug-in. If that scope or plug-in has delayed sweep operation you can easily cue the delay you need off of that trigger. When you want to use digital delay the output of the Word Recognizer is routed to an external trigger input to that unit instead.

The new digital delay units offer improved measurement ease and accuracy for many applications. Analog sweep delay is still the best solution in other areas. Tektronix plug-ins provide you the option of choosing either, or both, delaying capabilities. 

<sup>1</sup>Delay by count is discussed in the Jan/Feb 1974 issue of Tekscope, and the 7D11 is discussed in the Nov. 1972 issue of Tekscope.

<sup>2</sup>See Tekscope for Sept/Oct 1974

<sup>3</sup>See Tekscope for Mar/Apr 1974

# Time Measurement Accuracy

TEKTRONIX 475

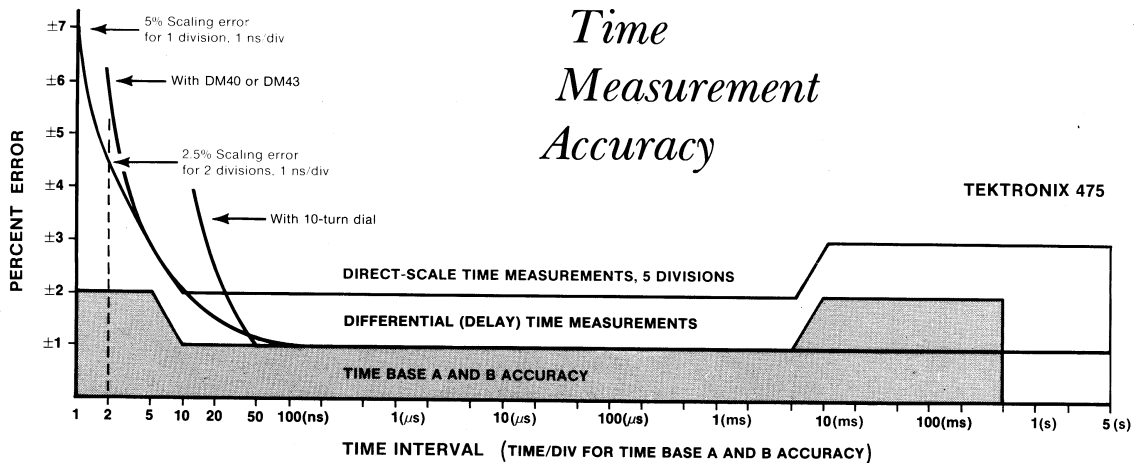

Time interval measurements made with an oscilloscope are made between two points on the displayed waveform that represent the beginning and end of the interval to be measured.

One way to make such a measurement is to scale the distance between those two points directly from the crt graticule. The distance will be proportional to the time interval.

Another way is to use a sweep delay control to position first one then the other of the two points to the same reference line on the crt graticule. The two numbers read from a dial or window represent the time interval measured. The difference between the two numbers will be proportional to the time interval. This method is called a differential time measurement. Both points in the waveform don't have to appear on the crt screen at the same time when making differential time measurements. Nor does the time/div selected, or sweep speed accuracy of the displayed sweep, have a direct bearing on the accuracy of the measurement.

When measurements are made by directly scaling the crt, special care must be used when reading and interpolating the scale to assure best measurement accuracy. Most observers agree that, with reasonable care, most measurements can be kept within  $\pm 1/20$  major divisions by interpolating the scale to the nearest  $1/10$ th major division. That amounts to a scaling error of  $\pm 5\%$  for one division of separation between two points in the waveform, but only amounts to  $\pm 1\%$  for five divisions of separation, etc. When the time/div on an oscilloscope is calibrated in a 1-2-5 sequence all time measurements can be spread over four divisions or more, except for time intervals less than four divisions of the fastest sweep. Because most measurements can be spread over more than five divisions, a  $\pm 1\%$  scaling error is a conservative figure for most measurements made with care.

Scaling errors should be algebraically added to the accuracy of the time base used for the measurement. You should assume time base accuracy is at the margin of the specified accuracy. The time base accuracy for the 475 is specified as  $\pm 2\%$  for the 1, 2 and 5 ns per division settings

and  $\pm 1\%$  for the other time/div settings. The blue curve on the graph shows time measurement accuracy when you combine scaling error with time/div errors.

The black curves show the accuracy you can expect when making differential time measurements with the TEKTRONIX 475 oscilloscope. The 475 is available with either the conventional 10-turn calibrated delay dial or with a digital multimeter, DM40 or DM43, integrally attached. The DM40 and DM43 allow you to set the first delay reading to zero so the second reading may indicate the time measurement directly. Pushing a button is all it takes. Numbers representing the time interval measured appear with  $3\frac{1}{2}$  digit resolution on four LED's. Curves for both types of 475's are shown.

The improvement in accuracy offered by the DM40 or DM43 over the conventional 10-turn dial is primarily for time intervals less than  $1/10$  of the delay range used. For the shortest delay range that amounts to 50 ns or less. The reason accuracy is better is primarily that the DM40 and DM43 provide five times better time resolution than the 10-turn dial. Accuracy with the 10-turn dial is  $\pm 0.1\%$  of the full 10-turn range for measurements involving a difference of less than one turn. Accuracy with the DM40 or DM43 is  $\pm 1\%$  of the reading,  $\pm 1$  count, with one count being equal to only  $0.02\%$  of the full range. Below about 5 ns, directly scaling the crt should improve accuracy.

When making differential time measurements, visual errors involved in positioning the trace are generally considered insignificant because the displayed sweep can be made very much faster than the delaying sweep. For example, a 50 ns time interval measured using the differential method can be displayed at 1 ns/div, and a visual error of  $\pm 1/20$ th division would amount to only  $\pm 50$  ps ( $\pm 0.1\%$ ). For similar reasons delay jitter or drift on the order of 1:20,000 or less seldom interferes significantly with the accuracy of a differential time measurement.

The convenience, speed, and freedom from human error with which accurate measurements may be made with the DM40 or DM43 recommend it most.

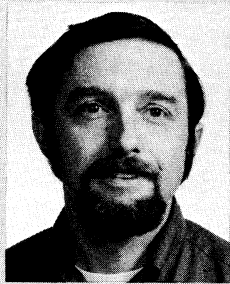

James Wagner

## Digital delay and time base in one plug-in

What you see through a window depends, to a large extent, on when you look through it. The oscilloscope is sometimes called the "window to electronics", and timing is of the essence in determining what will be viewed through this window. Most electrical events happen in milliseconds or microseconds, and some in nanoseconds or picoseconds. How can we view these events and their relationship to neighboring events?

Tektronix neatly solved this problem with the introduction of an oscilloscope with a delaying sweep. Delaying sweep enables you to look at a relatively long "time window", select any portion of that time window, and then view the selected portion in detail on a second time base called the delayed sweep. Delayed sweep can be thought of as a magnifying glass permitting you to view in great detail the events displayed in the long time window.

If you have ever looked through a hand-held magnifying glass you know that the greater the magnification, the more trouble you have holding it steady enough to view the object clearly. In electronic jargon we call this jitter. And we experience jitter to some degree when using delayed sweep to achieve a large degree of sweep magnification. Now, a new means of generating the time delay substantially reduces the jitter experienced in this type of measurement, and facilitates other kinds of delay measurements.

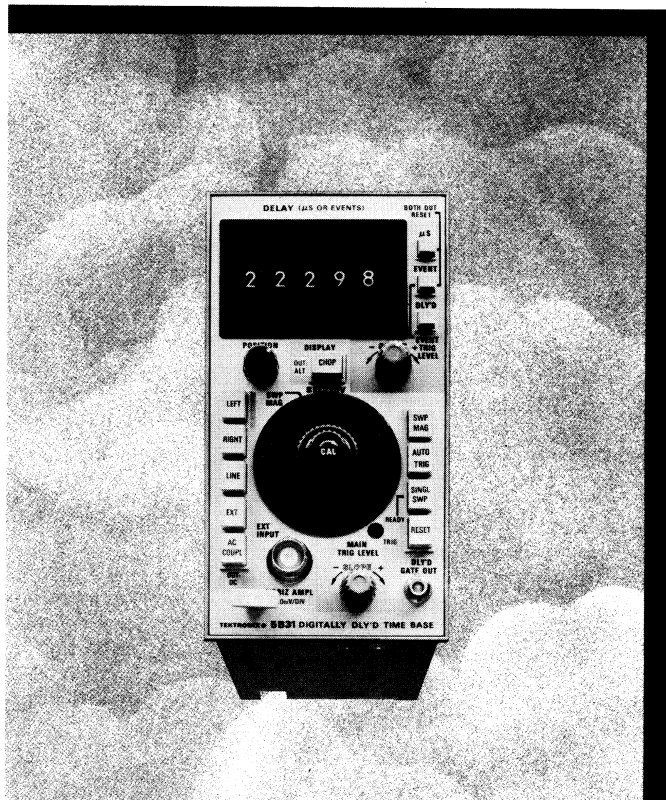

### Digitally delayed sweep

Electronic circuitry is becoming increasingly digital. In most digital systems the time relationship between events is determined by clock pulses. A convenient means of viewing a particular event in such a system is to count the clock pulses that must occur before the event takes place. The sweep is then triggered and the event we desire to view is displayed. Since the delay tracks the event regardless of its timing variation, jitter is eliminated or greatly reduced.

#### Delay by event

The new 5B31 Digitally Delayed Time Base brings just such a capability to TEKTRONIX 5400 Series Oscilloscopes. Operating in the delay by events mode, five thumbwheel switches permit you to select delays up to 99,999 events. The events can be as short as 20 ns in duration and at frequencies up to 20 MHz.

Delay by event is particularly useful when working with "floppy" discs\* or other rotating devices. Counting can be initiated by the index pulse on the disc, and the thumbwheels set to count the number of clock pulses to take you to that portion of the disc you're interested in viewing. Since you are triggering from the pulses recorded on the disc, jitter caused by variations in disc speed will not be apparent in the display.

#### Delay by time

For many applications delay by time is more suitable than delay by event. The 5B31 brings the benefits of digital delay to time delay measurements by means of an internal 1-MHz crystal-controlled clock. In delay by time operation we are again counting events but the events occur at precisely one microsecond intervals. The five thumbwheel switches provide a choice of delay times from 0 to 99,999  $\mu$ s. Differential delay time, that is, the difference in delay between two points on the same sweep, can be measured to an accuracy of 2 parts in  $10^5$ , or within 0.002%, considerably better than that achieved using analog sweep delay.

#### Reducing display jitter

Figure 1 shows how jitter originates in a simple clock and counter delay system where the clock is not triggered from the signal. Total delay time can vary as much as one clock period because there is a random interval between the trigger and the first clock transition counted. This random interval causes jitter. One way to minimize jitter is to select a high clock frequency. But this requires a fast counter in addition to the fast clock, and is expensive.

The 5B31 uses a unique circuit to achieve 10 ns or less of jitter using a 1 MHz clock. You would normally expect up to 1  $\mu$ s of jitter with this clock frequency.

A single fixed-rate ramp, referred to as the "held ramp", is used to absorb the random time between the

trigger and the first count. Figure 2 shows the relationship between the main trigger, the clock and the held ramp. The simplified block diagram in Figure 3 shows the major circuit elements used in generating the held ramp, and achieving digital delay.

In delay by time operation the  $\mu$ s pushbutton is depressed. When a trigger from the Main Trigger Generator occurs it gates the 1-MHz clock to the counter and, in conjunction with the Ramp Flip-Flop, turns on the Ramp Current Generator (held ramp). The ramp runs up until the Transition Detector senses the first change in the state of the counter. At this point the Ramp Flip-Flop switches, interrupting the ramp charging current. The ramp holds at the interrupted level until counting is completed. The End of Count Detector then switches the Ramp Flip-Flop, restoring the charging current. The held ramp then continues its run-up to the level set by the Comparator. Total run-up time is 1  $\mu$ s, excluding "hold" time.

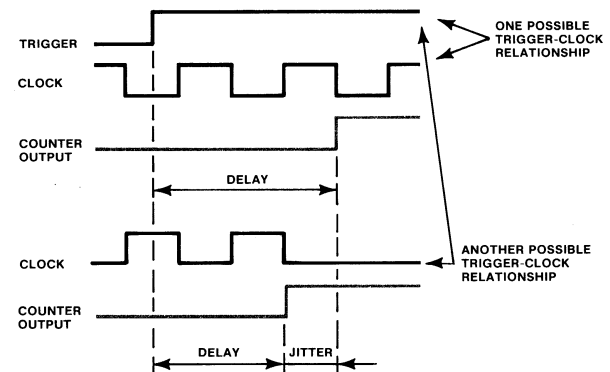

Fig. 1. Diagram illustrating why jitter occurs in a digital delay system when the clock is not triggered from the signal.

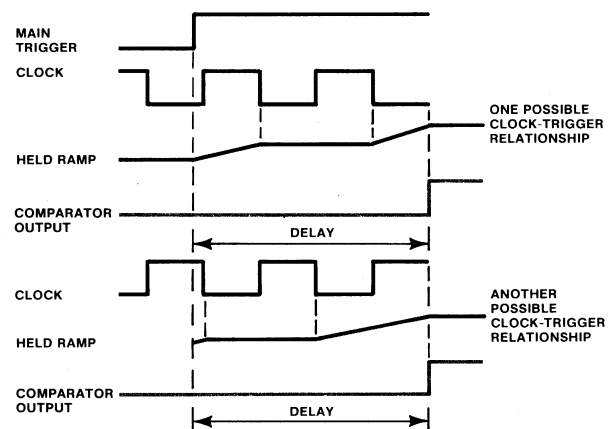

Fig. 2. Diagram illustrating how held-ramp operation accommodates differences in the clock-trigger relationship to reduce jitter to 10 ns or less.

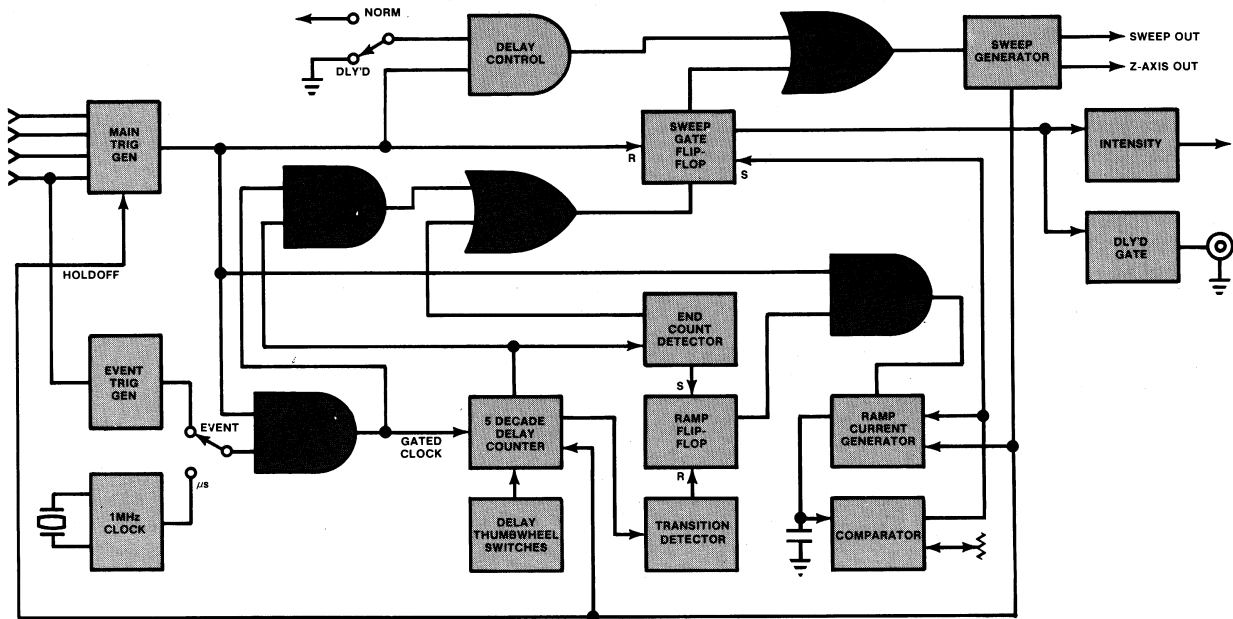

Fig. 3. Simplified block diagram of the 5B31 Digitally Delayed Time Base.

The Comparator output drives the Sweep Gate Flip-Flop which enables the Sweep Generator, and provides a signal for trace intensification and a Delayed Gate.

At the end of the sweep interval, information from the Delay Thumbwheel switches are loaded into the counter, and the Main Trigger Generator and the held ramp are reset.

The held ramp operation reduces jitter from the expected  $1 \mu\text{s}$  to  $10 \text{ ns}$  plus 1 part in  $10^7$  of selected delay. For time delays longer than  $200 \mu\text{s}$ , the 5B31 has less jitter than an analog sweep delay having a jitter spec of 1 part in 20,000 of delay range.

In delay by event operation, triggers from the Event Trigger Generator substitute for the 1-MHz clock. The Transition Detector, Ramp Flip-Flop and Ramp Current Generator are inoperative in this mode.

Operation begins with a trigger from the Main Trigger Generator. The Counter counts pulses from the Event Trigger Generator. At completion of the count, the End of Count Detector enables the clock input of the Sweep Gate Flip-Flop. The next pulse from the Event Trigger Generator switches the Sweep Gate Flip-Flop, thus eliminating the propagation delays associated with the Delay Counter. The outputs of the Sweep Gate Flip-Flop perform the same functions as in delay by time operation.

In normal (undelayed) operation the trigger from the Main Trigger Generator passes directly through the Delay Control AND gate, and an OR gate, to start

the Sweep Generator. With the  $\mu\text{s}$  or EVENT push-button depressed the trace will be brightened at the end of the delay set by the thumbwheels if the delay is within the range of the displayed sweep.

#### Summary

The 5B31 is the first time base plug-in to include digital delay. While the time delay range is not as broad as some analog delays available, the ease of operation, low jitter, improved delay time accuracies, and delay by event capability make the 5B31 Digitally Delayed Time Base a valuable addition to the 5400 Series Oscilloscope family.

\*See "Flexible Disc Measurements Simplified by Digital Delay", Jan/Feb 1974 Tekscope.

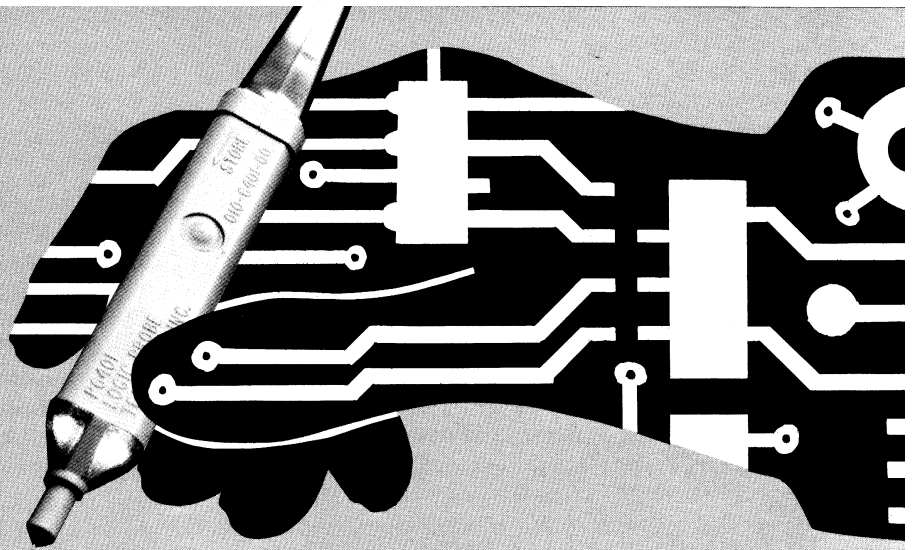

## Trouble - shooting digital circuits

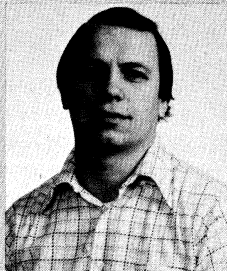

Roger Allen

### Troubleshooting digital circuits .....

*In the Nov/Dec 1974 issue of TEKSCOPE we introduced the subject of troubleshooting digital circuits with a summary of the fundamentals of flip-flops. That was because flip-flops are one of the basic microcircuits used in digital I.C.'s and are the most formidable of the basic circuits to become familiar with. If you are going to develop your troubleshooting skills beyond mere replacement of suspect circuit boards it is essential that you get to know basic logic circuits.*

**PART II** There are some good, practical tools around to help you troubleshoot digital circuits. They range in sophistication from logic probes to logic scopes, but the more sophisticated instruments are usually limited to production testing or engineering design work. The ordinary oscilloscope is usually the most sophisticated instrument practical to use for field service. Logic probes are the least expensive, the smallest, and with their indicator lights right on the probes, the handiest. Oscilloscopes are needed to show timing relationships between signals and show their precise voltage levels.

### The approach

There is such a variety of electronic products using digital circuits that you wonder how much you need to know about each product to find troubles fairly quickly. The answer depends on how much experience you have and what the products are, but we think beginners must understand at least enough to operate the product. Your ability to operate the equipment will have a great effect on where you begin the troubleshooting task.

There are usually several things you can do to test the operation of defective equipment that will help in isolating the problem area. You will need block diagrams and circuit diagrams to get acquainted with how the various parts of the equipment work together. When you have not had a chance to learn the equipment, taking time to read the titles of the blocks in a block diagram, and to read the names and labels of the important input and output lines gives you better information than you might suppose. You will surprise yourself.

The normal task of isolating a failure is to try to identify the section or area that probably contains the defect. In equipment that has lots of circuit boards one should first try to isolate the defective board. If replacement boards are not available, the next task is to find the specific defect, usually an I.C. Sometimes a defective I.C. may be quickly located by merely touching it with your finger to see if it is very hot. Power must be on, of course, and if there is any shock hazard possibility whatsoever you should not reach into the circuits to do this.

The place to start troubleshooting is at the symptom, the point where you are witnessing improper performance. You should try to create several symptoms of the problem because a comparison of symptoms will usually give a good clue to what basic function is not being performed. Knowing that and knowing the board that performs the function will get you close. Extra time spent at the outset with the symptoms will usually pay off by eliminating large sections of the circuits from consideration. For example, you may find that the equipment always misses a certain count, or that it only fails in one mode. Remember, however, that the problem cannot be fixed from the front panel unless it's an operator error. Once you have explored the symptoms thoroughly it is time to get inside the equipment.

#### **The first shot**

If you are able to reason where the trouble may be located you should change the board, if a spare is available. If normal operation is restored, you have identified the defective board and may confine further troubleshooting to that board. If it doesn't, you should change the remaining boards, one at a time, replacing each board in its original position.

In some cases you will not have any spare boards or be able to reason what board is most apt to be faulty from the available symptoms. In this case it is best to treat the equipment as if it were one unit and track the symptom back to wherever it leads you. Start at the point where you see the error. You might have a light that doesn't come on, or a wrong reading, etc. Starting at this point you should work your way back through the circuits, in fairly large steps, toward the normal origin of the missing signal or erroneous signal. Follow the circuit diagrams. Maybe the origin is a switch on the front panel that normally turns on a light that isn't working. Pick points to place your probe where the signal goes through fairly simple gates, if possible. These are the easiest points to check for proper operation. Eventually you will either find a point where the signal is blocked or you will wind up at the switch. Perhaps the switch is faulty.

When taking large jumps it is easy to skip the point where the problem is located. But once you find the signal you are looking for, you can stop going toward the origin and follow the signal in small jumps, checking each gate in the signal path until you find the point where the signal is blocked.

Now the signal can be blocked for several reasons. The component where it is blocked could be faulty, or another signal be missing at that point that would allow your signal to go through. A third possibility is that there are signals present which should not be there such as Preset, or Clear, or an Inhibit signal. If the

component plugs in, it is usually simplest to replace it and see if that solves the problem. If it doesn't, or if the IC is soldered in, you may need to do some more troubleshooting. Probe all the input and output lines, Vcc and ground. If one input does not have the right level, or right signal, you should pursue the cause for that in exactly the same way you started out.

If the schematic diagram or service manual does not show the basic make-up of that IC you will need to refer to the data book that the manufacturer of the IC supplies. Probe the pins of the device itself, not merely the socket, if it plugs in. Occasionally contacts in the socket are defective. In cases where a replacement component is not handy you may sometimes temporarily borrow one from another part of the equipment or from some other equipment. Be sure to put good components back in their original sockets.

Sometimes a Preset or Clear line is tripped so fast that you may not detect it with your logic probe or scope, if set up to look at slower signals. Sometimes you will need to increase the sweep speed of your scope to see these signals. At other times you may need to use the Single Sweep Ready light as an indicator that a single or low rep rate signal occurred. The Strobe mode or Hold mode on the TEKTRONIX P6401 Logic probe may be used for a similar check.

#### **The second shot . . . shorted outputs**

There are times when an IC may appear to be defective but is not. At such times your troubleshooting may have just begun and you will have to take a second shot. HIGH levels are never quite as high as the supply voltage level when things are working right. In a TTL circuit with a +5 volt Vcc supply level, for instance, HIGHs would normally be some level between about 3.5 to 4.5 volts depending on the load, although they theoretically can be as low as 2.4 volts. Measure the voltage level. If it measures the same as Vcc there is probably a short between Vcc and the output pin. The same simple test can be done for a LOW. If you can't find a few hundred millivolts on an output when it is LOW, it may be shorted to ground. If you have a HIGH at the output of an IC where there should be a LOW, it may be because the output is shorted to Vcc.

If you think you have found an output that is shorted, disconnect the circuit component that should be driving that line, lift the pin on the component that drives the line (as described later) and try again. If normal operation is restored at the floating pin, that component is OK. Bend the pin back and replace the component.

An output that is shorted may be the input to several other components and any one of them may be causing the trouble. If they are easy to disconnect, try one at a



time, being sure to get them back right. That bears repeating. Get them back right! Any trouble you accidentally put into a circuit that is already not working right will vastly complicate the problem. Two troubles at one time is more than double trouble. For this reason, avoid having two people troubleshoot the same job unless they work together closely and cooperate every step of the way. If someone besides yourself has been troubleshooting, *look* for double trouble. Suspect IC's to be plugged in backward or to be the wrong type.

Sometimes a shorted output may not be caused by a faulty component or socket. Solder "bridges" are a common kind of short. Look closely at all soldered points on the circuit board that are in close proximity to another conductor. Check any adjacent pair of solder points that look too close. Solder "tails" or lodged pieces of wire can usually be found by close inspection.

If you still can't find the short try using an ohmmeter with milliohm resolution. This is how: You turn off the power and remove the circuit board if convenient. Then you put the ohmmeter on the lowest scale and put one probe on the output pin and the other on ground or Vcc, depending on the nature of the short. You will measure only a low resistance if there is still a short. If you move the probe from the output along the circuit board run that connects to the pin, you should notice a decrease in resistance as you approach the locality of the short, and an increase in resistance as you move away from the short. Holding one probe lead very steady, move the other up and down the run to the point of minimum resistance. Stop at that point and repeat the procedure using the other probe lead. The short should be very close. You may have to use a magnifying glass to see some hairline shorts. Sometimes the sharp point of a scribe gently scraped between runs will remove a short.

The ohmmeter technique is especially good for locating shorts on a run that wanders all over the place, like if Vcc was shorted to ground.

In some cases it is hard to pinpoint a trouble because most everything indicates a particular IC should work, but it doesn't. These cases are usually caused by the IC output being overloaded or because input pulses are arriving that are hard to detect.

#### **Lift a pin or two**

If your IC's plug-in you can unplug any one, bend one of its pins out of the way of the socket, replace it and try again. To do this you should always use a pair of long-nose pliers and bend the pin right at the point where it comes out of the package. You will only need to bend it about 45° to clear the socket. See figure 1.

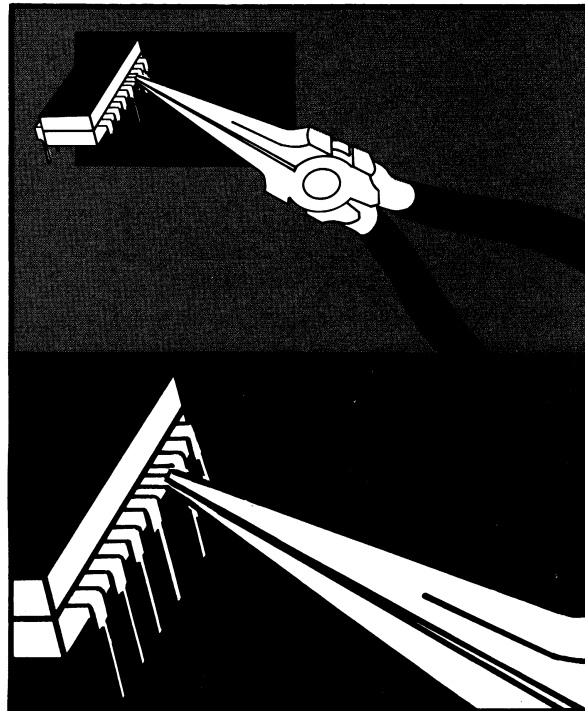

**Fig. 1.** When IC's are plugged into sockets you may isolate any lead by temporarily unplugging the IC and unbending the lead about 45° at the same region it was originally bent.

On flip-flops that don't seem to be working right (except that a new one doesn't fix the problem) you often need to lift more than one lead at a time. Narrow pulses are sometimes fed back to the Preset or Clear pin by a faulty IC elsewhere and will upset your attempt to go on. By lifting one, or both, of those pins you can usually tell where to look next. It will be necessary to tie some inputs either HIGH or LOW when they are lifted.

#### **Temperature sensitive intermittent problems**

You can't find troubles that are not there. The trouble that goes away when you start looking for it is the most elusive kind. Often that condition is a temperature sensitive one and you can make it occur by raising the temperature of one of the boards. The heat from a bench lamp or hand-held hair dryer is usually enough to do the job. But take care; you can sometimes quickly overheat a board that way.

When you can get a trouble to come and go by applying and removing heat to a whole area, you can usually finish the job quite quickly by combining the heating act with a cooling act. What you do is use a pressurized can of circuit coolant and spray different components while the board is hot. When the defective one is cooled the trouble will come on immediately.

When others are cooled it makes no difference. The blast of coolant should be brief and closely confined to the component suspected of being faulty. Sometimes you will think you have located the trouble spot when you are actually only close.

### Summary

1. Know basic AND gates, OR gates and flip-flops.
2. Know how to operate the equipment being serviced.
3. Study block diagrams and labels of input and output lines.
4. Create as many symptoms of the problem as you can to get the best clues about where to look.
5. Substitute good circuit boards for ones suspected to be faulty if they are available and can be changed quickly.
6. Carefully check temperature of components with your finger if there is no shock hazard.
7. Substitute good components for ones suspected to be faulty if they are available or can be borrowed.
8. Trace back through signal path from symptom toward normal origin of missing or faulty signal.
9. Take large steps toward origin until you find a normal signal, then small steps in direction of signal-flow to find where the signal is blocked.
10. Try to pick points to probe that are outputs of simple logic gates.
11. At point where signal is blocked look for defective component, missing or faulty input signal, or extra input signal.
12. Put original component back in socket if it is not defective.
13. Be sure to put boards and components back correctly.
14. Trace source of missing, faulty, or extra input signal the same way as when you first started at a primary symptom.
15. Probe pins on device not pins on socket.
16. Look carefully for single or low rep rate pulses.
17. Check for shorts or excessive load on output of I.C. where signal is blocked, when other factors seem normal.
18. Lift I.C. output pin to isolate from load if I.C. is not soldered in.
19. Lift I.C. input pins to identify faulty inputs of I.C. if it is not soldered in.
20. Heat boards to cause intermittent faults to occur.
21. Cool one component at a time and observe results on heated boards. 

\*See Nov/Dec 1974 issue of TEKSCOPE

## INSTRUMENTS FOR SALE

53/54D; \$40; Instruments, Inc., 3432 Midway Dr., San Diego, CA 92110. (714) 223-7156; c/o D. C. Kalbfell.

160, 161, 162, 163 & rack adapter; Sell or trade for 130 LC meter; Terry Perdue, 1470 Wilson Rd., St. Joseph, MI 49085; (616) 429-7566.

190, 105, 107, 180; \$500 total. 511AD; \$200; Dan Love; (213) 359-9141 X583.

211; \$650; Mark Kimball, Control Engineering Assoc., 1702 Riverdale St., W. Springfield, MA 01089; (413) 732-2936.

212; 10X attenuator pkg; BNC adapters; case; manuals; \$700; James Branchaud, Bell & Howell Co., Honolulu, HI; (808) 847-4056.

310 with access; \$300 or best offer; Tony Thomas, 3303 E. Denny Way, Seattle, WA 98122; (206) 655-4470.

422; Ceavco Audio-Visual Co., Inc.; 7475 W. 16th, Denver, CO 80215; (303) 238-8463. Ask for Steve or Paul.

422 with 2 probes; \$1000; Hugh Hansen; (213) 640-1291.

453 w/EMI Mod & miniature probes; \$1800; David Rimi, (214) 337-5454 or (214) 941-1255.

453, \$1250; 454, \$1800; RM561/2A60/3B1, \$575; D & K Plug-ins, \$35 ea.; W. A. Shirer, 9350 Carmichael Dr., La Mesa, CA 92041; (714) 466-3578.

465; \$1550; S. L. Shannon, (616) 965-8087; Battle Creek, MI.

465; \$1600; George Coomes, 16801 Veronica E Detroit, MI 48021; (313) 775-0843 Home or (313) 273-5855 Bsns.

507 (3); \$2300 ea.; A. R. Miller, Electro-Craft Inc., 1124 Dorchester Ave., Dorchester, MA 02125; (617) 825-0980.

512; \$200; Mr. Singhmanan, 122 Nelson Ave., Peekskill, NY 12550; (914) 737-6502.

514A; missing pwr. cord & probes; \$450; John L. Lenzo, 14 Hoffman Ave., Poughkeepsie, NY 12603; (914) 454-5335.

514D, 160A, 161, 162, 163; Best offer; Al Royce; (714) 734-0623.

517A (3); \$250 to \$400; Gene Wilkerson, Photographic Consultants, Inc., 10 Brookhill Rd., East Brunswick, NJ 08816; (201) 257-2794.

531 (2) with plug-ins & carts. Best offer over \$300 ea.; 422 (2). Best offer over \$475 ea.; General Kinetics Inc., 12300 Parklawn Dr., Rockville, MD 20852; (301) 881-2044.

531 with 2 plug-ins; \$350; R. Tsubota, Rt. 2, Box 442, Ontario, OR 97914.

531A, \$400; 533, \$400; CA \$165; 127 plug-in power supply, \$200; Kurt Dinsmore, Box 67, Richardson, TX 75080; (214) 238-0591.

531A, 1A1, B; \$600 or best offer; Eric Greenstein; 218 Foster St.; Brighton, MA 02135; (617) 783-0881.

532 with spare CRT & Access.; Wayne Burkhardt, RFD 2, Spencer, MA 01562; (617) 765-9711 X2318.

535-S2; 53/54C plug-in; Marty Planthold, Science Press, 300 W. Chestnut St., Ephrata, PA 17522; (717) 733-7981.

535, 53/54C, 53G, \$200; 105, \$40; misc plug-ins & Equip.; (215) 648-2477 Bsns; (215) 933-8175 after 5 p.m. Home. Ask for Roy Russell.

535A; \$850; Terry Barnum, Communications Systems of Albany, 6 Highland Ave., Albany, NY 12205; (518) 482-4435.

535A, CA; Bill Telekamp, MSI Data, 3180 Red Hill, Costa Mesa, CA 92626.

535A (2), CA (2); \$300 ea. scope with plug-in; Seymour Hamer, Telemet, 185 Dixon Ave., Amityville, NY 11701, (516) 541-3600.

545A/1A6/CA/P6013, C-27 Camera, cart; \$1000; F. H. Bratton, 2133 Birchwood Ave., Wilmette, IL 60091; (312) 256-2440 (eves).

545 w/CA; \$715; Mr. Richard Stan, 26177 6 Mile Road, Redford, MI 48219; (313) 533-6700 (Bsns), (313) 422-7698 (Home).

545A, G, 500/53A cart, 2 probes & hood; \$1100 or best offer; K. A. Murphy, Johns-Manville Prod. Corp., 814 Richmond Ave., Richmond, IN 47374; (317) 966-1561.

545L, \$695; 585-82, \$950; 661-5T3-4S2A, \$850; Frank Chance, S&C Sales Co., 319 Market St., Camden, NY 08101; (609) 963-5700.

549, 1A2 202-1 cart, best offer; Jim Warner, McGraw Edison, Olean, NY 14760; (716) 372-7700.

561, 2B67, 2A61; \$700; Leo Larsen, 4659 Is. Sh. Dr., Pinckney, MI 48169; (313) 229-4651 (eves).

564B Mod 121N w/3A6, 3A7, 3B3, 2B67; John Forster, Consulting Engineer, PO Box 48, M.I.T. Branch P.O., Cambridge, MA 02139.

564B w/3A6, 3B3, \$1800; 3A7, \$350 or best offer; Jairus Lincoln, 44 Chandler St., Somerville, MA 02144.

R568/3A2/3B2; \$1067; E.D.A., Box AE, Cupertino, CA 94014; Attn: F. Shriver; (415) 941-3968 or (415) 948-8812.

(3) 611; \$2750 ea.; G. Payne, Hughes Aircraft Co., 2020 Oceanside Blvd., Oceanside, CA 92054; (714) 757-1200 X314.

647 w/10A1 & 11B2; \$800; Solidstate Controls, Inc., 600 Oakland Park Ave., Columbus, OH 43214; Call Jeff Powell (614) 263-1886.

647A, 11B2A, 10A1; below 1/2 price; Michael Sherman; (213) 363-4401.

2901; Call (203) 446-0280.

4002A w/Joy Stick; Connie Shea, GTE Sylvania, Inc., 189 13th St., Needham Heights, MA 02194; (617) 449-2000 X2617.

7503 w/7A12 & 7B52, 181, 516, CA, 53/54B, R, Z, L plug-ins, 160/161/162/163; (213) 348-5524.

7504, 7A16, 7A15, 7B50, 7B51; best offer; Audrey Jackson, Epps Air Service; DeKalb Peachtree Airport, Chamblee, GA 30341; (404) 458-9851.

7504, 7T11, 7B53A, 7S11(2), S3A (2); best offer; Charles McQuire c/o Dynamic Measurements Co., 6 Lowell Ave., Winchester, MA 01890.

7613 w/7B53A, 15% off list; Gregory E. Peacock, Telaid Systems, Inc., 6725 Variel Ave., Canoga Park, CA 91303; (213) 884-5440.

7A15, Henry Kallina, 5th & Walnut, Atlantic, IA; (712) 243-2901.

7B51; \$275; Richard Baum, Electronic Instrument Labs Corp., PO Box 208, North Olmsted, OH 44070; (216) 779-7766.

7T11, 7S11; Sid Sanders, COMCO, 300 Greco Ave., Coral Gables, FL 33134; (305) 445-2671.

(5) C12-P. \$375 ea; (3) C12-PE, \$690 ea; (5) projected graticule 016-204-00, \$120 ea; John Belicka; (203) 348-5381.

C30A w/case, \$300; Ed Phillips, Programmed Power; (415) 323-8454.

C30A-P, 454; A. Okaya, Optical Data Products, 38 Vitti St., New Canaan, CT 06840; (203) 966-1432 or (203) 966-5968.

DC 502; Allen Drabicki, AJ Electronics, 7870 Hawthorne Dr., Liverpool, NY 13088; (315) 652-7425 (eves).

## INSTRUMENTS WANTED

DM 501, TM 503; 25% off list price; Jim Kavitz, Washington Electronics Service, 3368 Lee Highway, Bristol, VA 24201; (703) 466-9036.

DM 503 Opt 1, TM 503, FG 501, PS 503, 2601, 26A1, 26A2, 26G3; John Foster, N/J Electronics, PO Box 577, Laramie, WY 82070.

(4) FM 122, (1) RM 125 for FM 122, rack mount; \$100; Barry Fox, Optronics International, Inc., 7 Stuart Road, Chelmsford, MA 01824; (617) 256-4511.

TLD67 w/probes; \$700; Robert Rahn; (213) 360-0785.

TLD67, Don Relyea, Hoffrel Instrument, Norwalk, CT; (203) 866-9205.

106, 191; Frank Redder, Cornell Univ.; (607) 256-3552.

317; Dan Rasmussen, Jr., 323 Fuller St., Richland, WA 99352; (509) 943-3369.

324; Jerry Staab, Autometrics, 4946 N. 63rd St., Boulder, CO 80301; (303) 449-1662.

453 or 454; Cash; Dr. Gordon, 1435 W. 49th Place, Hialeah, FL 33012; (305) 822-1100.

533A, cart 202-2 or 202-1; Bob McKibben; (509) 943-9141 X31.

575 for 530 or 540; J. E. Fivecoate, Centaur Electronics, 743 S. Webster, Kokomo, IN 46901; (317) 452-2739.

4551, 4701; Robert Krause, Medical College of Pennsylvania, Cardiology Section, 3300 Henry Ave., Philadelphia, PA 19129.

1S1; Mike Levitt, Systems Concepts, 524 2nd St., San Francisco, CA 94107, (415) 494-2221.

1S1; Stuart Nelson, Systems Concepts, 524 2nd St. San Francisco, CA 94107; (415) 433-5400.

3A3, 3A9; Jerry Hall, Iowa State Univ.; (515) 294-1423.

3A9; Peter Costigan, 10 Quinton Drive, Nashua, NH 03060; (603) 882-7940 (eves).

3A73, 3A3; Dr. Ronald Hoy, Cornell Univ.; (607) 256-7473.

3A74; Jim Godwin, ROH Corp., 107 Technology Park, Norcross, GA 30071.

3B4; Dale W. Fitting, Memorial Hospital, Radiology Dept., 1924 Alcoa Hwy, Knoxville, TN 37920; (615) 971-3701.

7A15 or 7A18; Henry Kallina, 5th & Walnut, Atlantic, IA 50022; (712) 243-2901.

10A1; cash or trade for 11B2; Jeff Cook; (805) 962-1080.

82 & 81A plug-in; G. W. Hui, 5807, Gomer Pyle, San Antonio, TX 78240; (512) 696-6501 (Bsns), (512) 684-3940 (Home, weekends).

P6038; Mr. Leo Berries; GTE Sylvania, Box 360, Muncy, PA 17756; (717) 546-3191 X134.

Scope, 20 MHz, single trace minimum sensitivity 5 mV/div; Duane Johnson; (206) 624-7498.

# 1974 Tekscope Index

---

Jan/Feb 1974:	Volume 6 Number 1	30 Hz resolution at gigahertz frequencies — a new direction in spectrum analysis CRT Readout — nicety or necessity? Flexible disc measurements simplified by digital delay Servicing the 465 portable oscilloscope
Mar/April 1974:	Volume 6 Number 2	A 1000 cm/ $\mu$ s storage oscilloscope Using your oscilloscope probe Triggering the oscilloscope from logic signals Servicing the TELEQUIPMENT D67 Oscilloscope
May/June 1974:	Volume 6 Number 3	The 31/53 calculator-based measurement instrumentation package Using your oscilloscope probe Servicing the 7904 high-efficiency power supply
Sept/Oct 1974:	Volume 6 Number 4	A 400-MHz dual-beam oscilloscope The oscilloscope with the digital multimeter Op amp bandwidth approximations . . . using the 577/178 curve tracer Troubleshooting the 7B70 and 7B71 time bases
Nov/Dec 1974:	Volume 6 Number 5	What you need to know about testing 4k MOS memories The logic probe and the oscilloscope Understanding oscilloscope triggering controls Troubleshooting digital circuits

---



**TEKTRONIX®**

committed to  
technical excellence